

# D.O.T. Photocells™

ST-R15 / T15

## Installation guide



For use with:



SCD™ series



SCD mini™ series

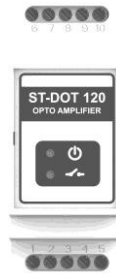

ST-DOT 120

- Up to 12m sensing range.
- High immunity to extraneous light and EMI/EMC sources.
- Molded design to comply with IP 67 rating.
- Various fittings for easy installation included.
- Compact transmitter available.

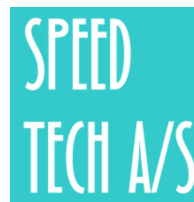

# INTRODUCTION

## The D.O.T. Photocell system:

These photo electric transmitters/receivers are reliable devices that incorporate high electrical noise immunity specifically designed for use with Speed Tech SCD and SCD mini door controller series and our ST-DOT 120 external amplifier.

To ensure optimal capabilities these devices are immune to extraneous light sources such as artificial and sunlight.

To withstand industrial environments the system is completely waterproof, meeting the ingress protection class 67 (IP 67).

The D.O.T. transmitters comes in two variants, the specifications are identical.

## Transmitters:

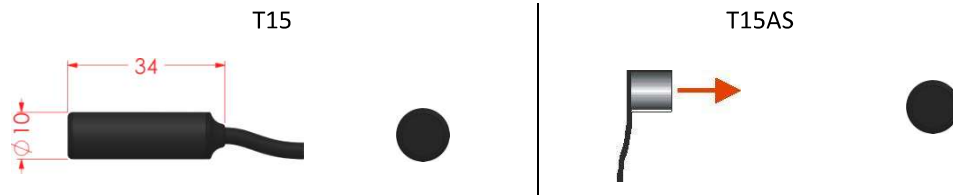

## Receivers:

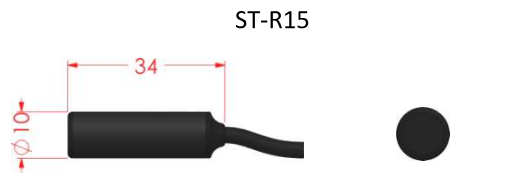

## Brackets:

One of each included with the T15, ST-R15 type

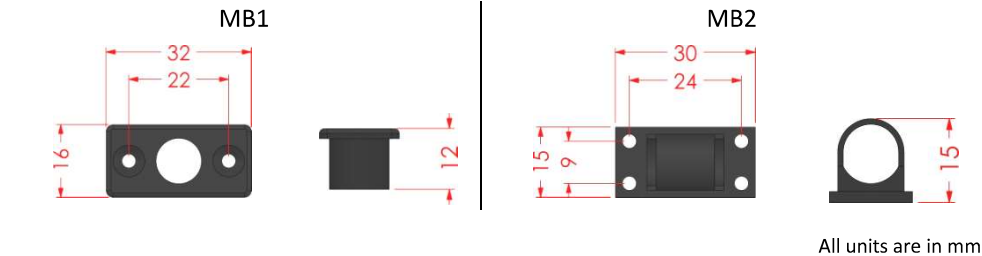

## CONNECTION

### Wire colors:

#### Attention:

Do only connect the photocells as shown below, incorrect connection can cause permanent damage to either the photocells, the door controller or both.

Wires:	Signal:
Red	Transmitter
White	Receiver
Copper/stranded wire	Neutral/0V

### Connect to a SCD series door controller:

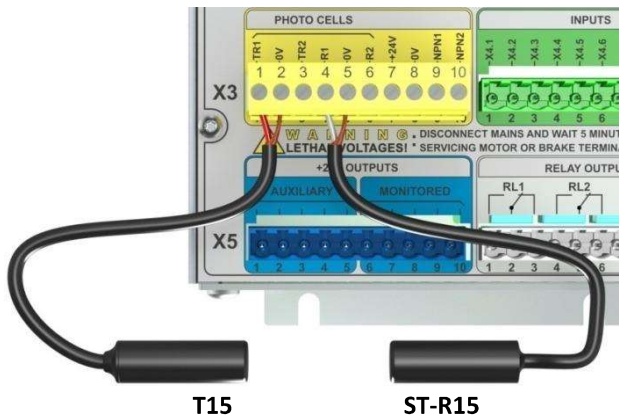

#### Connections:

Wire:	Terminal:
Red	X3.1
0V	X3.2
White	X3.4
0V	X3.5

### Connect to a SCD mini series door controller:

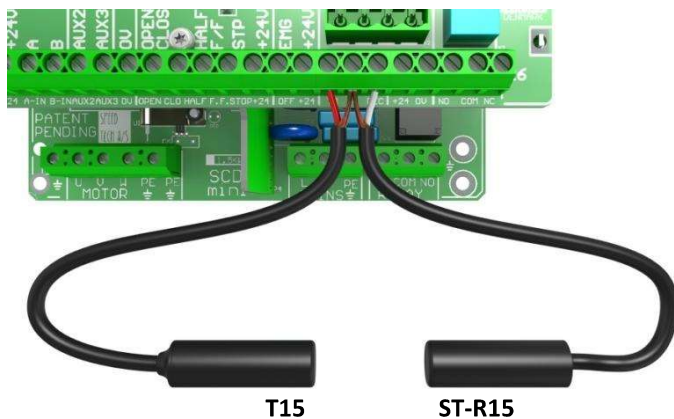

#### Connections:

Wire:	Terminal:
Red	19
0V	20
White	21
0V	20

## Connect to a ST-DOT120 :

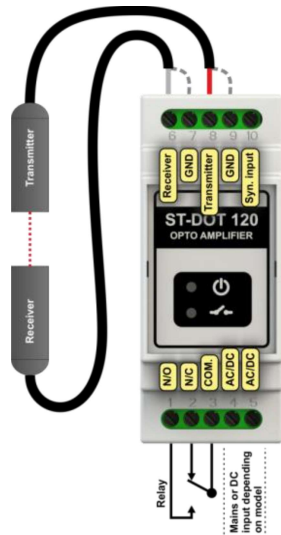

Terminal No:	Description:	
1		
2		
3		
4	Supply voltage – Depending on model	
5	230V AC / 24V A or DC	
6	RX (White)	ST-R15
7	RX shield	
8	TX (Red)	T15
9	TX shield	
10	Sync input (Master TX)	

## 🔧 ORDERING INFORMATION & TECHNICAL DATA

### Ordering:

Type:	Part no.:	Dimensions:
Transmitter T15	2329	Type R, Ø10x34 mm
Transmitter T15.AS	1289	Type R, Ø10x14 mm
Receiver ST-R15	2466-2	Type R, Ø10x34 mm

### Technical data:

Light source:	Infrared LED, invisible light
Sensitivity to sunlight:	100.000 lux at 10° from optical axis
Sensing range max:	12m
Moulding:	Themoplastic polymide
Housing	Polycarbonate with IR filter
Ingress Protection class:	67
Working temperature:	-30°C to +50°C
Cable specifications:	15m PVC insulated, single wire 1x0,14mm <sup>2</sup> with twisted shield
Weight:	160g

REV D – 24-04-2018

This product is designed and assembled in Denmark